

10"

Architectural LED Downlight

EPD-10

Edison Series

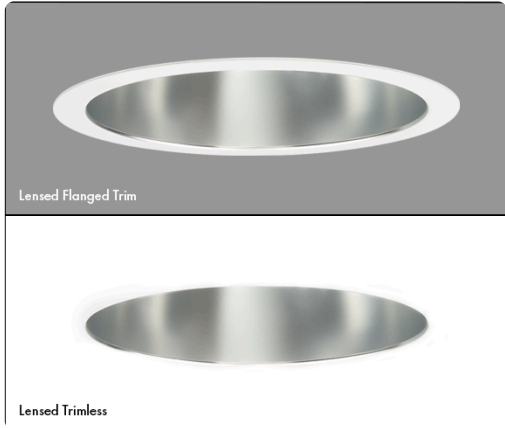

Application

A complete family of downlights, accent lights, wallwashers, double wallwashers, and corner wallwashers in multiple beam spreads and apertures designed for commercial, civic, museums, corporate, hospitality, academic, retail, medical, and houses of worship.

Features

- Exceptional Optical Quality: Up to 98 CRI, 1x2 Step MacAdam Ellipse.
- Shipped standard with a Solite Beam Smoother lens that removes striations from the light source.
- Available with a multitude of dimming protocols and control offerings.

Nominal Lumens	Delivered Lumens	Wattage
900L	1091	9
1200L	1439	12
1500L	1782	15
2000L	2382	21
3000L	3512	35
4000L	4793	40
6000L	6412	66
8000L	7789	81

Based on 4000K, 90+ CRI with semi-specular chrome reflector. Actual wattage may vary +/-5%

Lumens	High Performance: 900, 1200, 1500, 2000, 3000, 4000, 6000, 8000 Dims to Warm: 900, 1200, 1500, 2000, 3000, 4000 Xicato Artist: 900, 1200, 1500, 2000, 3000 Natural Spectrum: 900, 1200, 1500, 2000, 3000
CCT & Dynamic Platforms	High Performance: 22K, 27K, 30K, 35K, 40K, 50K Dims to Warm: 30K-18K, 30K-22K, 27K-18K Xicato Artist: 27K, 30K, 30K-VIB, 35K, 40K Natural Spectrum: 27K, 30K, 35K, 40K, 50K, 65K
CRI	High Performance: 90+, 98+ Dims to Warm: 90+ Xicato Artist: 98+ Natural Spectrum: 97+
Color Quality	2 Step MacAdam Ellipse
Distributions	NSPD (Narrow Spot 15°), SPD (Spot 24°), ND (Narrow 30°), MD (Medium 36°), MWD (Medium Wide 52°), WD (Wide 60°), VWD (Very Wide 70°)
Trim Options	Downlight, Wall Wash, Double Wall Wash, Corner Wall Wash, Wet Location
Reflector Colors	CL (Semi-Specular Chrome), SHZ (Low Iridescent Satin Haze), WT (Wheat), W (White), BK (Black), BZ (Bronze)
Flange Colors	TL (Trimless), WH (Self-Flanged White), SCH (Self-Flanged Semi-Specular Chrome), SHZ (Self-Flanged Low Iridescent Satin Haze), BK (Self-Flanged Black), BZ (Self-Flanged Bronze)
Dimming	DIM10, LUTH, LUTFTB, ELDO10.1-LIN, ELDODMX.1, ELDODALI.1, DIMTR, BLE-CASAMBI, POE, DIM10-0-OFF, ELDO10-LOG, XSR, DIM10-AUX
Emergency	EMG-LED-10W, EMG-LED-20W, INTG-EMG-LED-10W, INTG-EMG-LED-20W, EMG-LED-G2-10W-SDT
Lifetime	L70 at 102,000 Hours
Photometric Tests	In Accordance with IES LM79-08, LM80 and TM-30, TM-21



10"

Architectural LED Downlight

EPD-10

Edison Series

PART NUMBER: EPD-10-900L-22K-90-NSPD-DIM10-120V

Series	Lumens	CCT	CRI	Optics	Driver	Voltage	Emergency	Options
EPD-10	900L 1200L 1500L 2000L 3000L 4000L 6000L 8000L ⁶	22K 27K 30K 35K 40K 50K ¹	90+ 98+²	NSPD Narrow Spot (15°) SPD Spot (24°) ND Narrow (30°) MD Medium (36°) MWD Medium Wide (52°) WD Wide (60°) VWD Very Wide (70°)	DIM10 LUTH LUTFTB ⁴ ELDO10.1-LIN ELDODMX.1 ELDODALI.1 DIMTR ³ BLE-CASAMBI POE DIM10-0-OFF ELDO10-LOG XSR DIM10-AUX	120V 277V MVOLT 347V ⁵	- EMG-LED-10W EMG-LED-20W INTG-EMG-LED-10W INTG-EMG-LED-20W EMG-LED-G2-10W-SDT	- USA

¹ 50K series are available with 85+ CRI only ² 98+ CRI is available in 27K, 30K and 40K only ³ DIMTR available for luminaires up to 4000L in 120V only ⁴ LUTFTB Available for luminaires up to 1500L ⁵ 347V is available in only DIM10 ⁶ The 8000L is available in only DIM10

PART NUMBER: EPD-10-WDM-30K-18K-900L-90-NSPD-DIMTR-120V

Series	Technology	Lumens	CRI	Optics	Driver	Voltage	Emergency	Options
EPD-10-WDM (Dim to Warm)	30K-18K 30K-22K 27K-18K	900L 1200L 1500L 2000L 3000L 4000L	90+	NSPD Narrow Spot (15°) SPD Spot (24°) ND Narrow (30°) MD Medium (36°) MWD Medium Wide (52°) WD Wide (60°) VWD Very Wide (70°)	DIMTR¹ DIM10 LUTH ELDO10.1 ELDODALI.1 ELDODMX.1	120V 277V MVOLT 347V ²	- EMG-LED-10W EMG-LED-20W INTG-EMG-LED-10W INTG-EMG-LED-20W EMG-LED-G2-10W-SDT	- USA

¹ DIMTR available in 120V only ² 347V is available in only DIM10

10"

Architectural LED Downlight

EPD-10

Edison Series

PART NUMBER: **EPD-10-XIA-900L-27K-98-NSPD-DIM10-120V**

Series	Lumens	CCT	CRI	Optics	Driver	Voltage	Emergency	Options
EPD-10-XIA <i>(Xicato Artist)</i>	900L 1200L 1500L 2000L 3000L	27K 30K 30K-VIB 35K 40K	98+	NSPD Narrow Spot (15°) SPD Spot (24°) ND Narrow (30°) MD Medium (36°) MWD Medium Wide (52°) WD Wide (60°) VWD Very Wide (70°)	DIM10 LUTH LUTFTB⁴ ELDO10.1-LIN ELDODMX.1 ELDODALI.1 DIMTR³ BLE-CASAMBI POE DIM10-0-OFF ELDO10-LOG XSR DIM10-AUX	120V 277V MVOLT 347V³	- EMG-LED-10W EMG-LED-20W INTG-EMG-LED-10W INTG-EMG-LED-20W EMG-LED-G2-10W-SDT	- USA

¹ DIMTR available in 120V only ² LUTFTB Available for luminaires up to 1500L ³ 347V is available in only DIM10

PART NUMBER: **EPD-10-NSL-900L-27K-97-NSPD-DIM10-120V**

Series	Lumens	CCT	CRI	Optics	Driver	Voltage	Emergency	Options
EPD-10-NSL <i>(Natural Spectrum)</i>	900L 1200L 1500L 2000L 3000L	27K 30K 35K 40K 50K 65K	97+	NSPD Narrow Spot (15°) SPD Spot (24°) ND Narrow (30°) MD Medium (36°) MWD Medium Wide (52°) WD Wide (60°) VWD Very Wide (70°)	DIM10 LUTH LUTFTB⁴ ELDO10.1-LIN ELDODMX.1 ELDODALI.1 DIMTR³ BLE-CASAMBI POE DIM10-0-OFF ELDO10-LOG XSR DIM10-AUX	120V 277V MVOLT 347V³	- EMG-LED-10W EMG-LED-20W INTG-EMG-LED-10W INTG-EMG-LED-20W EMG-LED-G2-10W-SDT	- USA

¹ DIMTR available in 120V only ² LUTFTB Available for luminaires up to 1500L ³ 347V is available in only DIM10





















10"

Architectural LED Downlight

EPD-10

Edison Series

ORDER GUIDE

REFLECTOR TYPE				MOUNTING	COLOR						
REFLECTOR TYPE				MOUNTING	COLOR						
Open Downlight EPD-10-101 	Wall Wash EPD-10-107 	Double Wall Wash EPD-10-177 	Corner Wall Wash EPD-10-127 	Flanged 	ANODIZED FLANGED						
					Clear White CL-WH 	Satin Haze White SHZ-WH 	Black BK-BK 				
					Clear Semi-Spec CL-SCH 	White WH-WH 	Satin Haze SHZ-SHZ 				
								Clear Black CL-BK 	Black White BK-WH 	Wheat White WT-WH 	
Open Downlight EPD-10-TL-101 	Wall Wash EPD-10-TL-107 			Trimless 	ANODIZED TRIMLESS						
					White WH 	Black BK 	Clear CL 	Satin Haze SHZ 			



WWW.EPL.COM | 718.685.0700 | NEW YORK / LOS ANGELES

Modifications Available

Consult factory for modification requests; orders may require shop drawing approval.

Downlight

Our signature anodized reflector, spun to a reverse parabola design, achieves a 50° shielding angle and a 40° cut-off, which eliminates inter-reflections, and enhances low aperture brightness

Wall Wash

The optical assembly delivers uniform ceiling-to-floor wallwashing without creating any visible scallops. The optical assembly is specially designed to extend a beam in two directions for a uniform floor-to-ceiling and side-to-side wash of light.

Double Wall Wash

Used in a corridor to wash both walls, providing both horizontal and vertical illumination that fully illuminates corridors and hallways.

Corner Wall Wash

Replacing the effect that two luminaires provide, a corner wallwasher kicks light across corners that run perpendicular to one another, ultimately providing a 210° wash of light fully covering conjoined walls and surfaces.

Optical Performance and Trim

Spun aluminum anodized single piece reflector. The optical system consists of 1) an upper reflector for a precise beam spread; 2) a solite soft focus lens to diffuse the light source for smooth, striation-free distribution; 3) and a patented lens to control the beam angle and provide a 40° visual cutoff. Available in a variety of beam angles. Integral heatsink comes preinstalled on the housing for maximum heat dissipation and locks together with the reflector to prevent zero light leakage for above the ceiling.

Fully Servicable - Easy Installation & Upgrading

Housing maybe installed in ceilings of up to 1-1/2 inch thickness without the use of additional collars. Torsion springs on EPCh side of the reflector hold snug to the ceiling, and allows for fast, easy installation into housing, and fast removal for easy access to the junction box from below the ceiling.

Trim Design

Luminaire is designed for installation in sheetrock or T-Bar ceilings to achieve a flush trim detail.

- Trimless option has a perforated face. Installation includes the application of drywall compound over the luminaire's integral spackle screen to the rim of its integral plaster ring.

Housing / Mounting

16-gauge steel, preassembled one-piece construction with integral 27" C-channel mounting brackets included. Mounting brackets may be adjusted up to 28" horizontally, and 2-3/4" vertically, and locking into place.

Emergency Options/Controls

The test switch for the emergency battery can be installed on the side of the reflector (integral INTG-EMG option), or the test switch can be mounted remotely (EMG-LED option). Self Diagnostic emergency option available (EMG-SDT-LED-10W) Typical lumen output of the luminaire is up to 1000L with EMG-LED-10W or INTG-EMG-LED-10W option & 2000L with EMG-LED-20W or INTG-EMG-LED-20W option in emergency mode. Other accessories and controls systems include modular wiring systems, daylight harvesting controls, occupancy sensors, and/or power packs for individual or room control applications.

Drivers

120/277V 50/60Hz; 347V available. THD < 20%; power factor >.09. Thermally protected. Removal of the reflector provides complete accessibility to the junction box, driver and internal components from above and below the ceiling through the aperture.

Dim to Warm Option

Dims to Warm simulates traditional incandescent halogen lighting through dimming. When the luminaire dims to warm from 100% to .1%, it makes a smooth transition across the black body radiator while maintaining a constant CRI of 90+. Available in 30K-18K, 30K-22K or 27K-18K range.

Xicato Artist Series LED Module (XIA)

Powered by Xicato Artist Series®, which are tested to IES TM-30-15, with a color fidelity score (Rf) of 96 and a color gamut score (Rg) of 102, and color shift less than du'v' of 0.003. Featuring cold phosphor technology, improving thermal management enhancing color consistency and delaying lumen depreciation.

Natural Spectrum (NSL)

Natural Spectrum LED option id designed for Human Centric lighting application. Natural Spectrum LEDs diminish blue light peak, similar spectral curve to sunlight, accurate rendering of colors and reduced scattered reflection and glare.

Dimming & Driver Information

DIM10 - 0-10V dimming on either MVOLT 120, 277 or 347V. Dimmable down to 1% of initial lumens, standard

LUTH - Lutron LDE1 Hi-Lume Eco System with Soft Fade to Black 1% dimming

LUTFTB - Lutron PEQO Hi-Lume Premier Eco System LED Driver with soft-on fade to black 0.1% dimming

ELDO10.1-LIN - ELDO10-Linear with linear dimming curve.

ELDODMX.1 - EldoLED PowerDrive dimming down to 0.1%. Please see EldoLED website for wiring diagrams and a list of compatible DMX and DALI control systems.

ELDODALI.1 - EldoLED SoloDrive DALI-2. Dimming down to 0.1%

DIMTR - Triac & Electronic low voltage forward phase dimming. Available in 120V only

BLE-CASAMBI - Luminaires may be controlled, grouped, scheduled or placed in scenes , and or zones Via Cassambi Bluetooth 4.0 App.

POE - Power-over-Ethernet Depending on the PoE manufacturer selected

DIM10-0-OFF - Program DIM10-to OFF withlinear dimming curve 0.1%

ELDO10-LOG - ELDO10-LOG with logarithmic dimming curve.

XSR - Xitanium SR Dimming

DIM10-AUX - 0-10V with Auxiliry power

ELDO10.1 - EldoLED SoloDrive 0-10V. Dimming down to 0.1%

10"

Architectural LED Downlight

EPD-10

Edison Series

FLANGED

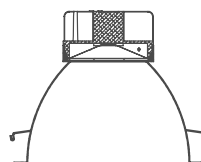
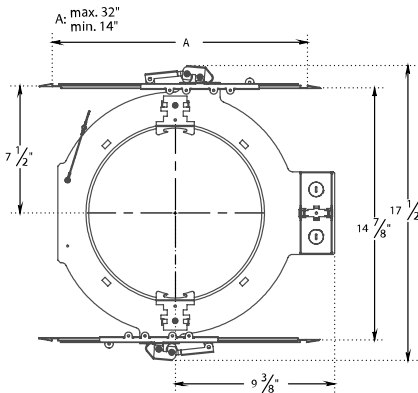
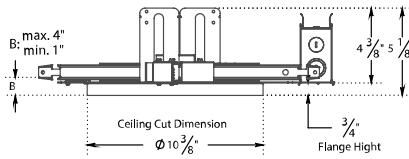
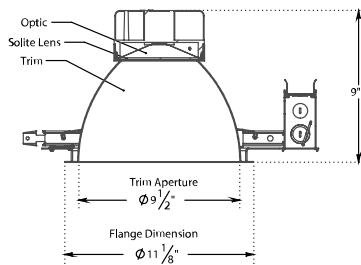
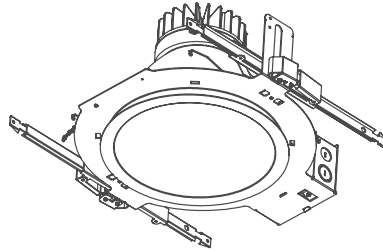

Downlight

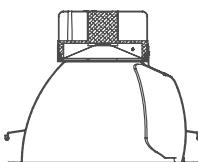

Wall Wash

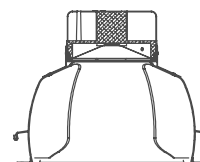

Double Wall Wash



10"

Architectural LED Downlight

EPD-10

Edison Series

EPD-10-4000L-40K-90-NSPD-DIM10-MVOLT-EPD-10-101-CL-WH

TEST NO: **EPL052522137**

INPUT WATTS: **41.0**

LUMENS: **4184**

EFFICACY: **102**

BEAM ANGLE: **20**

SPACING CRITERIA: **0.28**

CANDELA DISTRIBUTION

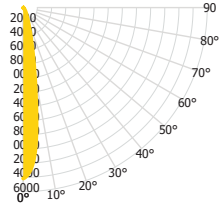

CANDELA TABLE

	0°	90°
0°	24139	24139
10°	9150	9564
20°	1889	1962
30°	638	664
40°	148	155
50°	24	27
60°	2	2
70°	1	1
80°	0	0
90°	0	0

LUMINANCE (cd/sq.m)

	0.00°	90.00°
0.00°	516915	516915
45.00°	2241	2201
55.00°	145	152
65.00°	52	52
75.00°	31	31
85.00°	17	15

LUMENS PER ZONE

ZONE	LUMENS
0° - 10°	1746
10° - 20°	1484
20° - 30°	592
30° - 40°	275
40° - 50°	74
50° - 60°	10
60° - 70°	1
70° - 80°	0
80° - 90°	0

ZONAL LUMEN SUMMARY

ZONE	LUMENS	% LUMINAIRE
0° - 20°	3230	77%
0° - 30°	3822	91%
0° - 40°	4097	98%
0° - 60°	4180	100%
0° - 80°	4182	100%
0° - 90°	4182	100%

CONE OF LIGHT

MOUNTING HEIGHT	FC AT BEAM CENTER	BEAM DIA. 0°-180°	BEAM DIA. 90°-270°
6.0 ft	670.5 fc	2.1 ft	2.1 ft
8.0 ft	377.2 fc	2.8 ft	2.8 ft
10.0 ft	241.4 fc	3.4 ft	3.4 ft
12.0 ft	167.6 fc	4.1 ft	4.1 ft
14.0 ft	123.2 fc	4.8 ft	4.8 ft
16.0 ft	94.3 fc	5.5 ft	5.5 ft
18.0 ft	74.5 fc	6.2 ft	6.2 ft
20.0 ft	60.3 fc	6.9 ft	6.9 ft

INDOOR COEFFICIENTS OF UTILIZATION

pw	80%			70%			20%			50%			30%			10%			0%
	70%	50%	30%	10%	70%	50%	30%	10%	50%	30%	10%	50%	30%	10%	50%	30%	10%	0%	
0	119	119	119	119	116	116	116	116	111	111	111	106	106	106	102	102	102	100	
1	115	113	111	109	113	111	109	107	107	105	104	103	102	101	100	99	98	97	
2	111	108	105	102	109	106	103	101	103	101	99	100	98	97	96	95	93	93	
3	108	103	99	97	106	102	98	96	99	97	94	97	95	93	95	93	92	90	
4	104	99	95	92	103	98	94	92	96	93	91	94	92	90	92	90	89	87	
5	101	95	91	88	100	95	91	88	93	90	87	92	89	87	90	88	86	85	
6	98	92	88	85	97	92	88	85	90	87	84	89	86	84	88	85	83	82	
7	96	89	85	82	95	89	85	82	88	84	82	87	84	81	86	83	81	80	
8	93	87	83	80	92	86	82	80	85	82	79	84	81	79	84	81	79	78	
9	91	84	80	78	90	84	80	77	83	80	77	82	79	77	82	79	77	76	
10	89	82	78	76	88	82	78	75	81	78	75	80	77	75	80	77	75	74	

EPD-10-4000L-40K-90-SPD-DIM10-MVOLT-EPD-10-101-CL-WH

TEST NO: **EPL052522137**

INPUT WATTS: **41.1**

LUMENS: **4623**

EFFICACY: **112**

BEAM ANGLE: **19**

SPACING CRITERIA: **0.29 x 0.29**

CANDELA DISTRIBUTION

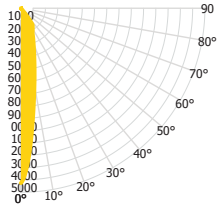

CANDELA TABLE

	0°	90°
0°	14248	14248
10°	6340	6305
20°	3009	3005
30°	1923	1912
40°	348	404
50°	63	65
60°	9	8
70°	3	3
80°	1	1
90°	0	0

LUMINANCE (cd/sq.m)

	0.00°	90.00°
0.00°	305111	305111
45.00°	3804	3776
55.00°	817	895
65.00°	268	263
75.00°	146	145
85.00°	52	34

LUMENS PER ZONE

ZONE	LUMENS
0° - 10°	954
10° - 20°	1336
20° - 30°	1148
30° - 40°	978
40° - 50°	165
50° - 60°	31
60° - 70°	6
70° - 80°	2
80° - 90°	0

ZONAL LUMEN SUMMARY

ZONE	LUMENS	% LUMINAIRE
0° - 20°	2291	50%
0° - 30°	3438	74%
0° - 40°	4416	96%
0° - 60°	4612	100%
0° - 80°	4620	100%
0° - 90°	4621	100%

CONE OF LIGHT

MOUNTING HEIGHT	FC AT BEAM CENTER	BEAM DIA. 0°-180°	BEAM DIA. 90°-270°
6.0 ft	395.8 fc	2.0 ft	2.1 ft
8.0 ft	222.6 fc	2.7 ft	2.7 ft
10.0 ft	142.5 fc	3.4 ft	3.4 ft
12.0 ft	98.9 fc	4.1 ft	4.1 ft
14.0 ft	72.7 fc	4.7 ft	4.8 ft
16.0 ft	55.7 fc	5.4 ft	5.5 ft
18.0 ft	44.0 fc	6.1 ft	6.2 ft
20.0 ft	35.6 fc	6.8 ft	6.9 ft

INDOOR COEFFICIENTS OF UTILIZATION

pw	80%			70%			20%			50%			30%			10%			0%
	70%	50%	30%	10%	70%	50%	30%	10%	50%	30%	10%	50%	30%	10%	50%	30%	10%	0%	
0	119	119	119	119	116	116	116	116	111	111	111	106	106	106	102	102	102	100	
1	114	111	109	107	111	109	107	105	105	104	102	101	100	99	98	97	96	94	
2	109	104	101	98	107	103	99	97	99	97	94	97	94	92	94	92	90	89	
3	104	98	94	90	102	97	93	89	94	91	88	92	89	86	90	87	85	84	
4	99	93	87	84	98	91	87	83	89	85	82	87	84	81	86	83	80	79	
5	95	87	82	78	93	86	82	78	85	80	77	83	79	76	82	78	76	74	
6	91	83	77	73	89	82	77	73	81	76	73	79	75	72	78	74	72	70	
7	87	79	73	69	86	78	73	69	77	72	69	76	71	68	75	71	68	67	
8	83	75	69	66	82	74	69	65	73	69	65	72	68	65	71	68	65	63	
9	80	71	66	62	79	71	66	62	70	65	62	69	65	62	68	64	62	60	
10	77	68	63	59	76	68	63	59	67	62	59	66	62	59	66	62	59	58	



WWW.EPL.COM | 718.685.0700 | NEW YORK / LOS ANGELES

10"

Architectural LED Downlight

EPD-10

Edison Series

EPD-10-4000L-40K-90-ND-DIM10-MVOLT-EPD-10-101-CL-WH TEST NO: **EPL052522137**

INPUT WATTS: **40.9** LUMENS: **4793** EFFICACY: **117** BEAM ANGLE: **27** SPACING CRITERIA: **0.42**

CANDELA DISTRIBUTION

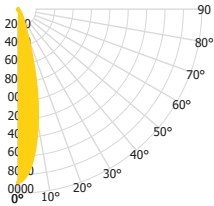

CANDELA TABLE

	0°	90°
0°	18830	18830
10°	12053	12706
20°	2468	2830
30°	746	735
40°	175	170
50°	28	30
60°	2	2
70°	1	1
80°	0	0
90°	0	0

LUMINANCE (cd/sq.m)

	0.00°	90.00°
0.00°	403217	403217
10°	2805	2737
20°	166	172
30°	63	63
40°	37	38
50°	20	17

LUMENS PER ZONE

ZONE	LUMENS
0° - 10°	1530
10° - 20°	2101
20° - 30°	739
30° - 40°	317
40° - 50°	90
50° - 60°	11
60° - 70°	1
70° - 80°	1
80° - 90°	0

ZONAL LUMEN SUMMARY

ZONE	LUMENS	% LUMINAIRE
0° - 20°	3631	76%
0° - 30°	4370	91%
0° - 40°	4687	98%
0° - 60°	4788	100%
0° - 80°	4790	100%
0° - 90°	4790	100%

CONE OF LIGHT

MOUNTING HEIGHT	FC AT BEAM CENTER	BEAM DIA. 0°-180°	BEAM DIA. 90°-270°
6.0 ft	523.0 fc	2.9 ft	2.9 ft
8.0 ft	294.2 fc	3.9 ft	3.8 ft
10.0 ft	188.3 fc	4.9 ft	4.8 ft
12.0 ft	130.8 fc	5.8 ft	5.8 ft
14.0 ft	96.1 fc	6.8 ft	6.7 ft
16.0 ft	73.6 fc	7.8 ft	7.7 ft
18.0 ft	58.1 fc	8.8 ft	8.7 ft
20.0 ft	47.1 fc	9.7 ft	9.6 ft

INDOOR COEFFICIENTS OF UTILIZATION

pf	pc	20%																0%			
		80%				70%				50%				30%							
pw	70%	50%	30%	10%	70%	50%	30%	10%	50%	30%	10%	50%	30%	10%	50%	30%	10%	50%	30%	10%	0%
0	119	119	119	119	116	116	116	116	111	111	111	106	106	106	102	102	102	102	100	100	0%
1	115	113	111	109	112	110	109	107	106	105	104	103	102	101	99	99	98	98	96	96	0%
2	111	107	104	101	109	105	103	100	102	100	98	99	98	96	97	95	94	92	92	92	0%
3	107	102	98	95	105	101	97	95	98	95	93	96	94	92	94	92	90	89	89	89	0%
4	103	98	94	91	102	97	93	90	95	92	89	93	90	88	91	89	87	86	86	86	0%
5	100	94	90	86	99	93	89	86	91	88	85	90	87	85	89	86	84	83	83	83	0%
6	97	90	86	83	96	90	86	83	88	85	82	87	84	82	86	83	81	80	80	80	0%
7	94	87	83	80	93	87	83	80	86	82	79	84	81	79	83	81	78	77	77	77	0%
8	91	84	80	77	90	84	80	77	83	79	77	82	79	76	81	78	76	75	75	75	0%
9	89	82	77	74	88	81	77	74	80	77	74	80	76	74	79	76	74	73	73	73	0%
10	86	79	75	72	85	79	75	72	78	74	72	77	74	72	77	74	72	71	71	71	0%

CANDELA DISTRIBUTION

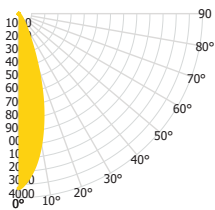

CANDELA TABLE

	0°	90°
0°	13289	13289
10°	9799	9908
20°	3837	3977
30°	814	815
40°	163	158
50°	25	27
60°	2	2
70°	1	1
80°	0	0
90°	0	0

LUMINANCE (cd/sq.m)

	0.00°	90.00°
0.00°	284582	284582
10°	2689	2571
20°	150	165
30°	60	60
40°	36	36
50°	17	17

LUMENS PER ZONE

ZONE	LUMENS
0° - 10°	1130
10° - 20°	2104
20° - 30°	1103
30° - 40°	324
40° - 50°	85
50° - 60°	11
60° - 70°	1
70° - 80°	1
80° - 90°	0

ZONAL LUMEN SUMMARY

ZONE	LUMENS	% LUMINAIRE
0° - 20°	3233	68%
0° - 30°	4337	91%
0° - 40°	4660	98%
0° - 60°	4756	100%
0° - 80°	4758	100%
0° - 90°	4758	100%

CONE OF LIGHT

MOUNTING HEIGHT	FC AT BEAM CENTER	BEAM DIA. 0°-180°	BEAM DIA. 90°-270°
6.0 ft	369.2 fc	3.6 ft	3.6 ft
8.0 ft	207.6 fc	4.8 ft	4.8 ft
10.0 ft	132.9 fc	6.0 ft	6.1 ft
12.0 ft	92.3 fc	7.2 ft	7.3 ft
14.0 ft	67.8 fc	8.5 ft	8.5 ft
16.0 ft	51.9 fc	9.7 ft	9.7 ft
18.0 ft	41.0 fc	10.9 ft	10.9 ft
20.0 ft	33.2 fc	12.1 ft	12.1 ft

INDOOR COEFFICIENTS OF UTILIZATION

pf	pc	20%																0%			
		80%				70%				50%				30%							
pw	70%	50%	30%	10%	70%	50%	30%	10%	50%	30%	10%	50%	30%	10%	50%	30%	10%	50%	30%	10%	0%
0	119	119	119	119	116	116	116	116	111	111	111	106	106	106	102	102	102	102	100	100	0%
1	115	112	110	108	112	110	108	107	106	105	103	102	101	99	99	98	98	96	96	96	0%
2	110	106	103	100	108	105	102	99	101	99	97	99	97	95	96	94	93	91	91	91	0%
3	106	101	97	94	104	100	96	93	97	94	92	95	92	90	93	91	89	87	87	87	0%
4	102	96	92	89	101	95	91	88	93	90	87	91	88	86	89	87	85	84	84	84	0%
5	99	92	87	84	97	91	87	84	89	86	83	88	85	82	86	84	82	80	80	80	0%
6	95	88	83	80	94	87	83	80	86	82	79	85	81	79	83	81	78	77	77	77	0%
7	92	85	80	76	91	84	79	76	83	79	76	82	78	76	81	78	75	74	74	74	0%
8	89	81	77	73	88	81	76	73	80	76	73	79	75	73	78	75	72	71	71	71	0%
9	86	78	74	70	85	78	73	70	77	73	70	76	73	70	75	72	70	69	69	69	0%
10	83	75	71	68	82	75	71	68	74	70	68	74	70	67	73	70	67	66	66	66	0%



10"

Architectural LED Downlight

EPD-10

Edison Series

EPD-10-4000L-40K-90-MWD-DIM10-MVOLT-EPD-10-101-CL-WH

TEST NO: EPL052522137

INPUT WATTS: **40.8** LUMENS: **4279** EFFICACY: **105** BEAM ANGLE: **47** SPACING CRITERIA: **0.67**

CANDELA DISTRIBUTION

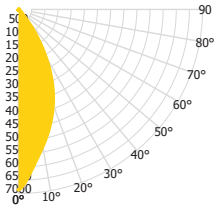

CONE OF LIGHT

MOUNTING HEIGHT	FC AT BEAM CENTER	BEAM DIA. 0°-180°	BEAM DIA. 90°-270°
6.0 ft	190.4 fc	5.2 ft	5.2 ft
8.0 ft	107.1 fc	7.0 ft	6.9 ft
10.0 ft	68.5 fc	8.7 ft	8.6 ft
12.0 ft	47.6 fc	10.5 ft	10.4 ft
14.0 ft	35.0 fc	12.2 ft	12.1 ft
16.0 ft	26.8 fc	13.9 ft	13.8 ft
18.0 ft	21.2 fc	15.7 ft	15.5 ft
20.0 ft	17.1 fc	17.4 ft	17.3 ft

CANDELA TABLE

	0°	90°
0°	6855	6855
10°	5279	5214
20°	3820	3782
30°	1998	1953
40°	256	240
50°	24	29
60°	3	3
70°	1	1
80°	0	0
90°	0	0

LUMINANCE (cd/sq.m)

	0.00°	90.00°
0.00°	146785	146785
10°	3367	3157
20°	179	187
30°	90	90
40°	58	59
50°	27	25
60°		
70°		
80°		
90°		

LUMENS PER ZONE

ZONE	LUMENS
0° - 10°	573
10° - 20°	1326
20° - 30°	1456
30° - 40°	790
40° - 50°	118
50° - 60°	11
60° - 70°	2
70° - 80°	1
80° - 90°	0

ZONAL LUMEN SUMMARY

ZONE	LUMENS	% LUMINAIRE
0° - 20°	1899	44%
0° - 30°	3355	78%
0° - 40°	4145	97%
0° - 60°	4274	100%
0° - 80°	4277	100%
0° - 90°	4277	100%

INDOOR COEFFICIENTS OF UTILIZATION

pc	pw	20%																0%				
		80%				70%				50%				30%					10%			
		70%	50%	30%	10%	70%	50%	30%	10%	50%	30%	10%	50%	30%	10%	50%	30%	10%	50%	30%	10%	0%
0	119	119	119	119	119	116	116	116	116	111	111	111	106	106	106	102	102	102	102	102	102	100
1	114	111	109	107	111	109	107	105	105	103	102	101	100	99	98	97	96	94	96	94	92	94
2	109	104	100	97	106	102	99	96	99	96	94	96	94	92	94	92	94	92	90	88	88	88
3	104	98	93	89	102	96	92	89	94	90	87	91	88	86	89	87	85	83	83	82	79	78
4	99	92	87	83	97	91	86	82	89	85	81	87	83	80	85	82	79	78	75	73	73	73
5	94	87	81	77	93	86	81	77	84	79	76	82	78	75	81	77	75	73	70	69	69	69
6	90	82	76	72	89	81	76	72	79	75	71	78	74	71	77	73	70	69	66	65	65	65
7	86	77	72	68	85	77	71	67	75	71	67	74	70	67	73	69	66	65	62	62	62	62
8	82	73	68	64	81	73	67	64	72	67	63	71	66	63	70	66	63	62	60	59	58	58
9	78	69	64	60	77	69	64	60	68	63	60	67	63	60	66	62	59	58	56	55	55	55
10	75	66	61	57	74	66	60	57	65	60	57	64	60	57	63	59	56	55	53	52	52	52

EPD-10-4000L-40K-90-WD-DIM10-MVOLT-EPD-10-101-CL-WH

TEST NO: EPL052522137

INPUT WATTS: **40.9** LUMENS: **4241** EFFICACY: **104** BEAM ANGLE: **35** SPACING CRITERIA: **0.52**

CANDELA DISTRIBUTION

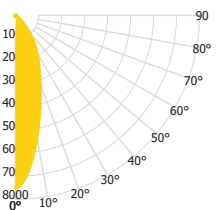

CONE OF LIGHT

MOUNTING HEIGHT	FC AT BEAM CENTER	BEAM DIA. 0°-180°	BEAM DIA. 90°-270°
6.0 ft	208.4 fc	3.8 ft	3.8 ft
8.0 ft	117.2 fc	5.0 ft	5.1 ft
10.0 ft	75.0 fc	6.3 ft	6.3 ft
12.0 ft	52.1 fc	7.5 ft	7.6 ft
14.0 ft	38.3 fc	8.8 ft	8.8 ft
16.0 ft	29.3 fc	10.1 ft	10.1 ft
18.0 ft	23.2 fc	11.3 ft	11.4 ft
20.0 ft	18.8 fc	12.6 ft	12.6 ft

CANDELA TABLE

	0°	90°
0°	7501	7501
10°	5307	5235
20°	3071	3055
30°	1786	1785
40°	702	725
50°	100	102
60°	8	8
70°	3	3
80°	1	1
90°	0	0

LUMINANCE (cd/sq.m)

	0.00°	90.00°
0.00°	160631	160631
10°	8282	9142
20°	763	936
30°	261	262
40°	139	143
50°	49	44
60°		
70°		
80°		
90°		

LUMENS PER ZONE

ZONE	LUMENS
0° - 10°	620
10° - 20°	1211
20° - 30°	1168
30° - 40°	878
40° - 50°	313
50° - 60°	41
60° - 70°	6
70° - 80°	2
80° - 90°	0

ZONAL LUMEN SUMMARY

ZONE	LUMENS	% LUMINAIRE
0° - 20°	1831	43%
0° - 30°	2999	71%
0° - 40°	3877	91%
0° - 60°	4230	100%
0° - 80°	4238	100%
0° - 90°	4239	100%

INDOOR COEFFICIENTS OF UTILIZATION

pc	pw	20%																0%				
		80%				70%				50%				30%					10%			
		70%	50%	30%	10%	70%	50%	30%	10%	50%	30%	10%	50%	30%	10%	50%	30%	10%	50%	30%	10%	0%
0	119	119	119	119	119	116	116	116	116	111	111	111	106	106	106	102	102	102	102	102	102	100
1	114	111	109	106	111	109	107	105	105	103	101	101	100	98	98	97	96	94	96	94	92	94
2	108	103	100	96	106	102	98	95	99	96	93	96	93	91	93	91	89	88	88	88	85	88
3	103	97	92	88	101	95	91	87	93	89	86	90	87	85	88	85	83	82	82	82	82	82
4	98	91	85	81	96	89	84	81	87	83	80	85	82	79	83	80	78	76	76	76	76	76
5	93	85	79	75	92	84	79	75	82	78	74	81	77	74	79	76	73	71	71	71	71	71
6	89	80	74	70	87	79	74	70	78	73	69	76	72	69	75	71	68	67	67	67	67	67
7	84	75	70	66	83	75	69	65	74	69	65	72	68	65	71	67	64	63	63	63	63	63
8	81	71	66	62	79	71	65	61	70	65	61	69	64	61	68	64	61	59	59	59	59	59
9	77	68	62	58	76	67	62	58	66	61	58	65	61	58	65	60	57	56	56	56	56	56
10	74	64	59	55	73	64	58	55	63	58	55	62	58	54	62	57	54	53	53	53	53	53



WWW.EPL.COM | 718.685.0700 | NEW YORK / LOS ANGELES

10"

Architectural LED Downlight

EPD-10

Edison Series

EPD-10-4000L-40K-90-VWD-DIM10-MVOLT-EPD-10-101-CL-WH

TEST NO: EPL052522137

INPUT WATTS: **41.0** LUMENS: **3990** EFFICACY: **97** BEAM ANGLE: **48** SPACING CRITERIA: **0.69 x 0.69**

CANDELA DISTRIBUTION

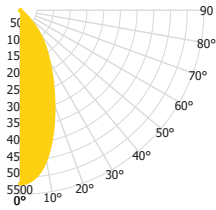

CANDELA TABLE

	0°	90°
0°	5182	5182
10°	4498	4477
20°	2922	2958
30°	1670	1707
40°	807	850
50°	126	140
60°	8	9
70°	3	3
80°	1	1
90°	0	0

LUMINANCE (cd/sq.m)

	0.00°	90.00°
0.00°	110978	110978
45.00°	11801	13149
55.00°	740	1065
65.00°	261	262
75.00°	139	141
85.00°	54	44

LUMENS PER ZONE

ZONE	LUMENS
0° - 10°	470
10° - 20°	1090
20° - 30°	1120
30° - 40°	851
40° - 50°	398
50° - 60°	50
60° - 70°	6
70° - 80°	2
80° - 90°	0

ZONAL LUMEN SUMMARY

ZONE	LUMENS	% LUMINAIRE
0° - 20°	1560	39%
0° - 30°	2681	67%
0° - 40°	3532	89%
0° - 60°	3979	100%
0° - 80°	3988	100%
0° - 90°	3988	100%

CONE OF LIGHT

MOUNTING HEIGHT	FC AT BEAM CENTER	BEAM DIA. 0°-180°	BEAM DIA. 90°-270°
6.0 ft	144.0 fc	5.3 ft	5.3 ft
8.0 ft	81.0 fc	7.1 ft	7.1 ft
10.0 ft	51.8 fc	8.8 ft	8.8 ft
12.0 ft	36.0 fc	10.6 ft	10.6 ft
14.0 ft	26.4 fc	12.4 ft	12.3 ft
16.0 ft	20.2 fc	14.1 ft	14.1 ft
18.0 ft	16.0 fc	15.9 ft	15.9 ft
20.0 ft	13.0 fc	17.7 ft	17.6 ft

INDOOR COEFFICIENTS OF UTILIZATION

pf	80%																70%																20%																0%
	80%				70%				50%				30%				10%				0%				0%																								
pc	70%	50%	30%	10%	70%	50%	30%	10%	50%	30%	10%	50%	30%	10%	50%	30%	10%	50%	30%	10%	50%	30%	10%	50%	30%	10%	0%																						
pw	70%	50%	30%	10%	70%	50%	30%	10%	50%	30%	10%	50%	30%	10%	50%	30%	10%	50%	30%	10%	50%	30%	10%	50%	30%	10%	0%																						
0	119	119	119	119	116	116	116	116	111	111	111	106	106	106	102	102	102	102	100	100	100	100	100	100	100	100	100	0%																					
1	113	111	108	106	111	108	106	104	104	103	101	101	99	98	97	96	96	95	93	93	93	93	93	93	93	93	93	0%																					
2	108	103	99	95	106	101	97	94	98	95	92	95	92	90	92	90	92	90	88	87	87	87	87	87	87	87	87	0%																					
3	102	96	91	87	100	94	90	86	92	88	85	89	86	83	87	84	82	80	82	80	80	80	80	80	80	80	80	0%																					
4	97	89	84	79	95	88	83	79	86	82	78	84	80	77	82	79	76	75	76	75	75	75	75	75	75	75	75	0%																					
5	92	83	78	73	90	83	77	73	81	76	72	79	75	72	77	74	71	69	71	69	69	69	69	69	69	69	69	0%																					
6	87	78	72	68	86	77	72	68	76	71	67	75	70	67	73	69	66	65	66	65	65	65	65	65	65	65	65	0%																					
7	83	73	67	63	82	73	67	63	72	66	63	70	66	62	69	65	62	61	62	61	61	61	61	61	61	61	61	0%																					
8	79	69	63	59	78	69	63	59	68	62	59	66	62	58	66	61	58	57	58	57	57	57	57	57	57	57	57	0%																					
9	75	65	59	55	74	65	59	55	64	59	55	63	58	55	62	58	55	53	55	53	53	53	53	53	53	53	53	0%																					
10	72	62	56	52	71	61	56	52	61	55	52	60	55	52	59	55	52	50	52	50	50	50	50	50	50	50	50	0%																					



WWW.EPL.COM | 718.685.0700 | NEW YORK / LOS ANGELES